



COLO // PORTAS

COLEÇÃO PORTAS 2015
DOORS COLLECTION 2015

QUEBEC

ENGENHARIA DE CONSTRUÇÃO
DOOR PROFILE



PORTA Ref. 04 / alumínio
DOOR Ref. 04 / aluminium

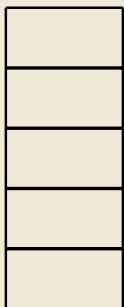

MOLDURA Ref. M3 90° | BATENTE Ref. 42
FRAME Ref. M3 90° | JAMB Ref. 42



90°

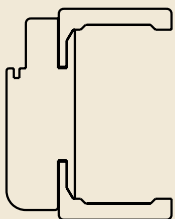

COR Wenghe
COLOR Wenghe

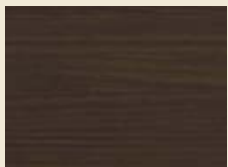

ENGENHARIA DE CONSTRUÇÃO
DOOR PROFILE



PORTA Ref. 04 / frisos
DOOR Ref. 04 / grooves

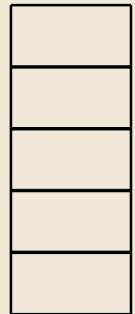

MOLDURA Ref. M3 90° | BATENTE Ref. 42
FRAME Ref. M3 90° | JAMB Ref. 42

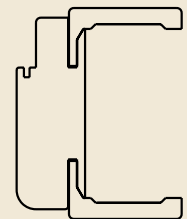

COR RAL 9003
COLOR Ral 9003

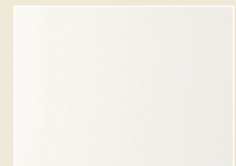

ENGENHARIA DE CONSTRUÇÃO
DOOR PROFILE



PORTA Ref. 02 / alumínio
DOOR Ref. 02 / aluminium

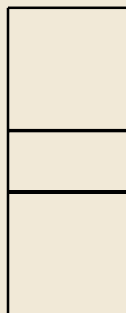

MOLDURA Ref. M3 90° | BATENTE Ref. 42
FRAME Ref. M3 90° | JAMB Ref. 42

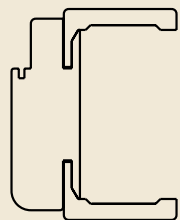

COR Rovere Sbiancato
COLOR Rovere Sbiancato



VIENA



**ENGENHARIA DE
CONSTRUÇÃO**
DOOR PROFILE



PORTA Ref. 01 pnl
DOOR Ref. 01 pnl



MOLDURA Ref. M8 45° | BATENTE Ref. 42
FRAME Ref. M8 45° | JAMB Ref. 42

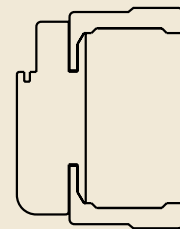

COR RAL 9003
COLOR Ral 9003

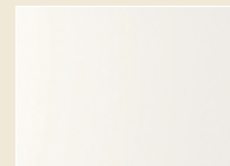

MONTREAL

ENGENHARIA DE CONSTRUÇÃO
DOOR PROFILE



PORTA Ref. 07 pnl
DOOR Ref. 07 pnl

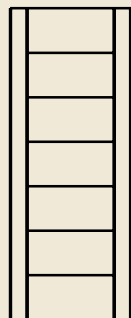

MOLDURA Ref. M3 45° | BATENTE Ref. 42
FRAME Ref. M3 45° | JAMB Ref. 42

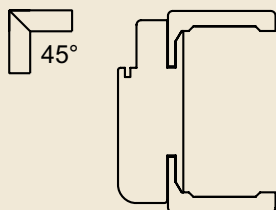

COR RAL 9003
COLOR Ral 9003

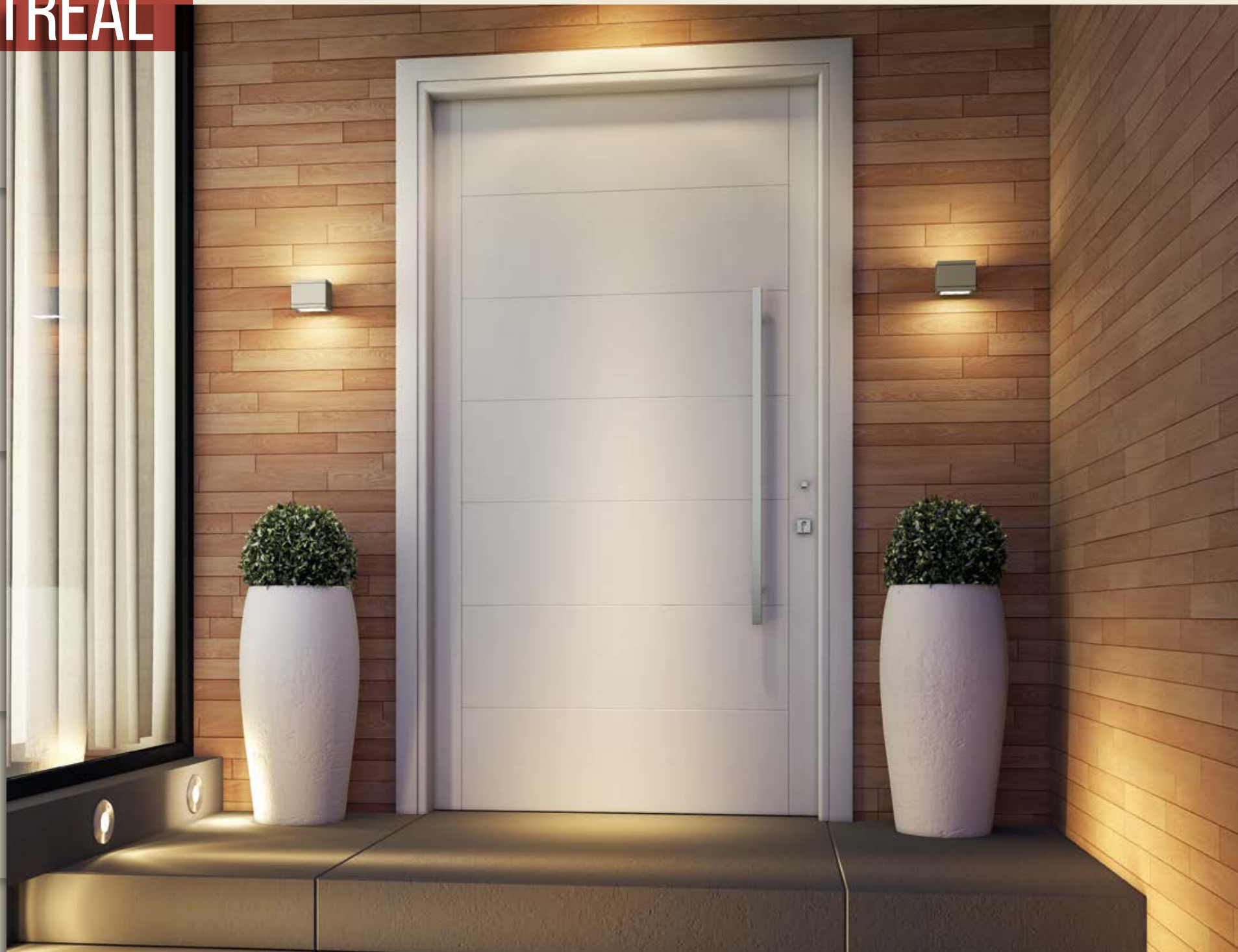
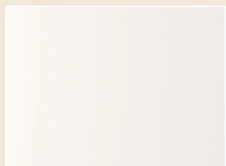



ENGENHARIA DE CONSTRUÇÃO
DOOR PROFILE



PORTA Ref. 02
DOOR Ref. 02

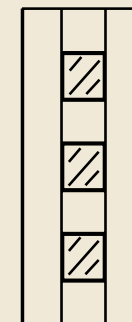

MOLDURA Ref. M3 90° | BATENTE Ref. 42
FRAME Ref. M3 90° | JAMB Ref. 42

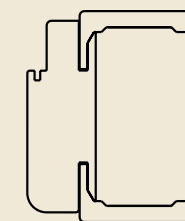

COR RAL 9003
COLOR Ral 9003

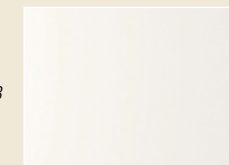

LONDON

ENGENHARIA DE CONSTRUÇÃO
DOOR PROFILE



PORTA Ref. 02 pnl
DOOR Ref. 02 pnl

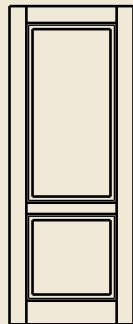

MOLDURA Ref. M13 45° | BATENTE Ref. 42
FRAME Ref. M13 45° | JAMB Ref. 42

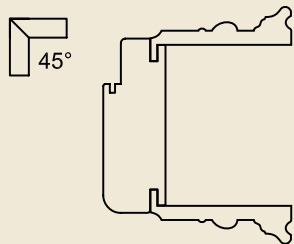

COR RAL 9003
COLOR Ral 9003

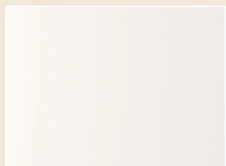

LONDON

ENGENHARIA DE CONSTRUÇÃO
DOOR PROFILE



PORTA Ref. 01 pnl
DOOR Ref. 01 pnl



MOLDURA Ref. M4 45° | BATENTE Ref. 42
FRAME Ref. M4 45° | JAMB Ref. 42

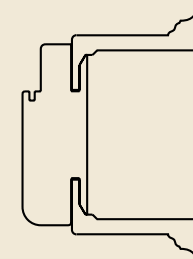

COR RAL 9003
COLOR Ral 9003

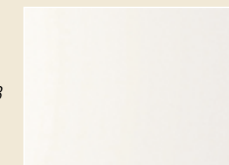

MONTREAL

ENGENHARIA DE CONSTRUÇÃO
DOOR PROFILE



PORTA Ref. 03
DOOR Ref. 03

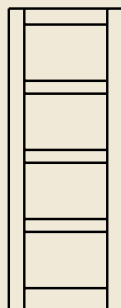

MOLDURA Ref. M3 90° | BATENTE Ref. 42
FRAME Ref. M3 90° | JAMB Ref. 42

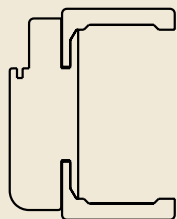

COR RAL 9003
COLOR Ral 9003

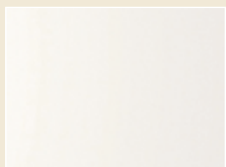

MONTREAL

ENGENHARIA DE CONSTRUÇÃO
DOOR PROFILE



PORTA Ref. 11
DOOR Ref. 11



MOLDURA Ref. M7 45° | BATENTE Ref. 42,8
FRAME Ref. M7 45° | JAMB Ref. 42,8



45°

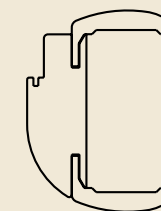

COR RAL 9003
COLOR Ral 9003

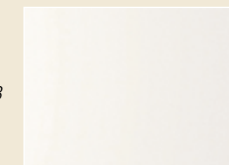

PADRÕES CORES / COLOUR

LACA / LACQUER



RAL 9003



RAL 9010



RAL 1013



RAL 7032

MADEIRA / WOOD



WENGHE



NOCE



MIELE



CILIEGIO



ROVERE SBIANCATO



WHITE VARNISH

RODAPÉS / BASEBOARD



RETO 10 cm / 18 x 100 mm



RETO 15 cm / 18 x 150 mm



RETO 20 cm / 18 x 200 mm



CLÁSSICO 18 x 150 mm

VIDRO / GLASS



Clear
Transparente



Clear Beveled
Transparente Bivelado



Laminado Translúcido
Satin Laminated

DIMENSÕES / DIMENSIONS

Abertura	FOLHA DA PORTA			VÃO DA ALVENARIA c/ PISO ACABADO		REBAIXO
	ESP.	LARG.	COMP.	LARG.	COMP.	
GIRO	42	600	2100	690	2160	
GIRO	42	700	2100	790	2160	
GIRO	42	800	2100	890	2160	
GIRO	42	900	2100	990	2160	
GIRO	35	600	2100	670	2150	
GIRO	35	700	2100	770	2150	
GIRO	35	800	2100	870	2150	
GIRO	35	900	2100	970	2150	
CORRER	35 e 42	600	2100	670	2150	1300
CORRER	35 e 42	700	2100	770	2150	1500
CORRER	35 e 42	800	2100	870	2150	1700
CORRER	35 e 42	900	2100	970	2150	1900
PIVOT	42	1050	2100	1180	2180	
PIVOT	42	1150	2100	1280	2180	
PIVOT	42	1050	2300	1180	2380	
PIVOT	42	1150	2300	1280	2380	

BATENTE E MOLDURA / JAMB & FRAME



JAMB 42 / BATENTE 42
FRAME M13 / MOLDURA M13

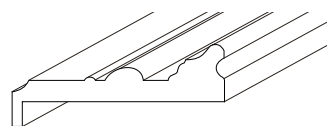

M13 - 34 X 130 mm



JAMB 42 / BATENTE 42
FRAME M02 / MOLDURA M02

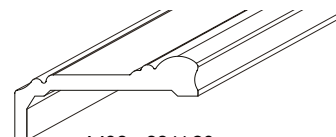

M02 - 22 X 90 mm



JAMB 42 / BATENTE 42
FRAME M04 / MOLDURA M04

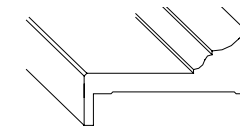

M04 - 34 X 92 mm



JAMB 42,8 / BATENTE 42,8
FRAME M07 / MOLDURA M07

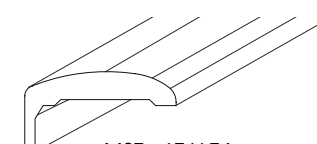

M07 - 17 X 74 mm

ABERTURA / OPENING

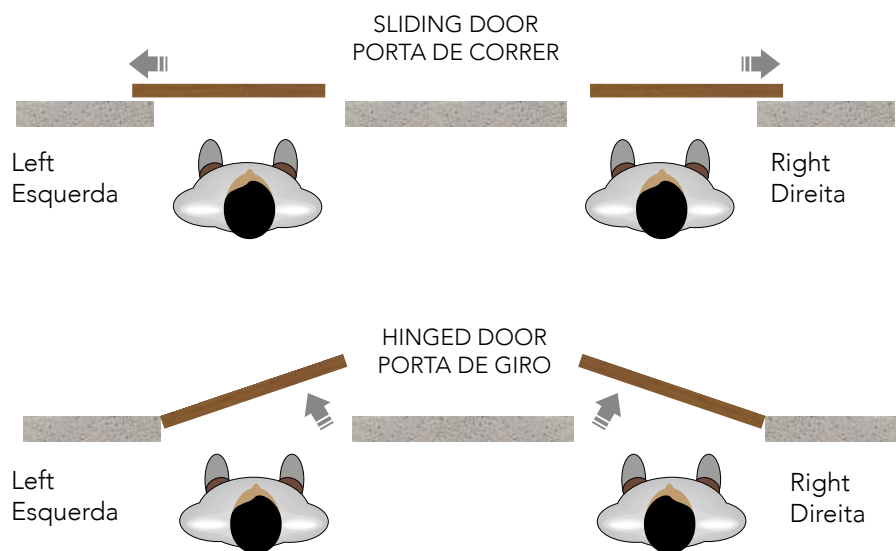

AJUSTE DA MOLDURA FRAME ADJUSTMENT

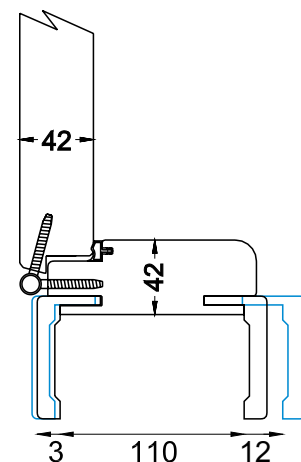

MAXIMUM ADJUSTMENT 15 mm
AJUSTE MÁXIMO 15 mm



JAMB 42 / BATENTE 42
FRAME M03 / MOLDURA M03

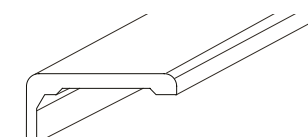

M03 - 15 X 70 mm



JAMB 42 / BATENTE 42
FRAME M08 / MOLDURA M08

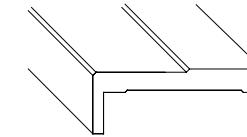

M08 - 15 X 80 mm

DOBRADIÇA 3D AJUSTÁVEL
3D ADJUSTABLE HINGE

FECHADURA C/ CILINDRO DESCENTRADO
LAYING OFF CENTRE CILYNDER

SISTEMA DE ABERTURA EUROPEU OPDEK
OPDEK OPENING

ESPESSURA 42 mm



THICKNESS 42 mm



DOBRADIÇA INOX COM ANEL
INOX HINGE

FECHADURA C/ CILINDRO CENTRADO
CENTERED CILYNDER

SISTEMA DE ABERTURA PADRÃO
STOMP OPENING

ESPESSURA 35 mm



THICKNESS 35 mm



MAÇANETAS / LEVER HANDLES



DORIC



TWIST IP (INOX)



SQUARE IP (INOX)



SLIM



TWIST IE (INOX)



SQUARE IE (INOX)

CAVAS / PULLS



CAVA 22 CHAVE



CAVA 22 TRANQUETA



REF. 22



REF. 32



REF. 52

TRILHO EXPOSTO / SLIDING DOOR



FECHADURA DE SEGURANÇA
SAFETY LOCK



SEG. 3 PINOS



SEG. 3 PINOS + TRINCO



SEG. 3 PINOS + ROLETE



COLO // PORTAS

Colo Ind. e Com. de Artefatos
de Madeira Ltda.

Rua José Frosch, 1570 | Mafra
Santa Catarina | 89300-000 | Brazil
Phone: 55 47 3642-4761
Fax: 55 47 3642-2604
e-mail: colo@colo.com.br

www.colo.com.br

